

Article number: 0101057  
 Description: Retaining ring A 40 DIN 471  
 Spring steel  
 Note: Fitted with ZGA pilers

## Measures

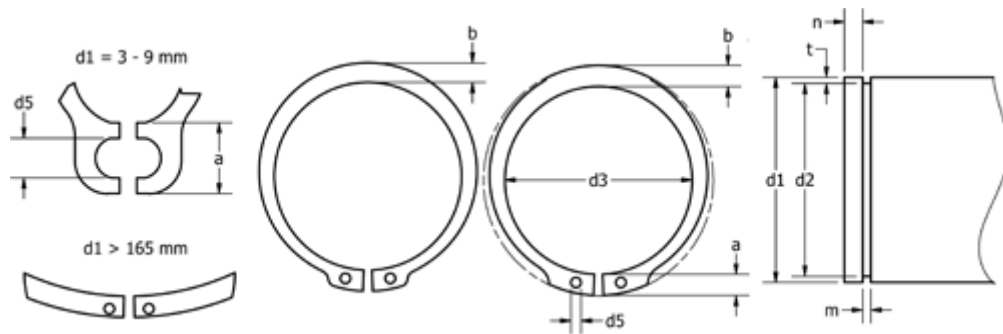

a max	= 6.0	FN kN	= 25.3	s	= 1.75
AN mm <sup>2</sup>	= 152.0	FRg kN	= 9.50	t	= 1.25
b	= 4.4	FR kN	= 51.00	tol	= -0.25
d1	= 40	g	= 2.0	tol	= -0.06
d2	= 37.5	K kN-mm	= 97.00	tol	= +0,39-0,90
d3	= 36.5	m min	= 1.85	Tong	= ZGA-3
d5 min	= 2.5	n abl x 1000	= 14.0	Weight kg/1000	= 6.030
Description	= A40	Nominal drive	= 3.8		